



Eurotherm®

Adaptable Power Control Expertise

EPack™-1PH Compact SCR Power Controllers



Benefits

OEMs and system integrators need to be able to react quickly to customer needs while maximizing resources. End users continually need to improve operational efficiency and productivity. EPack power controllers have been designed to deliver real savings, helping to reduce energy costs. Quick and easy to install, integrate and commission. Its compact size also offers powerful and versatile features that help to minimize costs, whilst improving productivity and quality.

- Easy choice with limited hardware variants and stock holding
- Fast integration and commissioning
- Monitor efficiently with integrated measurements
- Help maximize yield with accurate and repeatable control
- Improved energy consumption to help reduce energy bills
- Pay only for option needed

Unique features





- Native communication: Modbus® TCP and EtherNet/IP or PROFINET; or EtherCAT comms for easy connection to PLC
- True power control with current limitation
- Large voltage capability from 100V to 500V adjustable in the same variant
- Measurements: Current, voltage, Power, impedance, energy usage and more
- SCCR 100kA with fuse

eurotherm.com/epack

Life Is On

Schneider
Electric

Specifications

General	
Directive	EMC directive 2014/30/EU Low Voltage Directive 2014/35/EU
Safety Specification	EN60947-4-3:2014
EMC Emissions Specification	EN60947-4-3:2014 - Class A product
EMC Immunity Specification	EN60947-4-3:2014
Vibration Tests	EN60947-1 annex Q category E
Shock Tests	EN60947-1 annex Q category E
Approvals	
 European Community	EN60947-4-3:2014: Low-voltage switchgear and controlgear - Part 4-3: Contactors and motor-starters - AC semiconductor controllers and contactors for non-motor loads (identical to IEC60947-4-3:2014) Declaration of Conformity available on request.
 US & Canada	UL60947-4-1 CAN/CSA C22.2 NO.60947-4-1-14 Low-Voltage Switchgear and Controlgear - Part 4-1: Contactors and Motor-Starters - Electromechanical Contactors and Motor-Starters - U.L. File N° E86160
 Australia	Regulatory Compliance Mark (RCM) to Australian Communication and Media Authority Based on compliance to EN60947-4-3:2014
China	Product not listed in catalog of products subject to China Compulsory Certification (CCC)
Communication	 EtherCAT: ETG certification for Semiconductor industry is not yet available. Waiting for SDP profile  EtherNet/IP: ODVA Declaration of Conformity
Protection	CE: 16 to 63A > IP10 according to EN60529 80 to 125A > IP20 according to EN60529 UL: open type

Condition Of Use	
Atmosphere	Non-corrosive, non-explosive, non-conductive
Degree Of Pollution	Degree 2
Storage Temperature	-25°C to 70°C (maximum)
Usage Temperature	0 to 45°C at 1000m 0 to 40°C at 2000m
Altitude	1000m maximum at 45°C 2000m maximum at 40°C

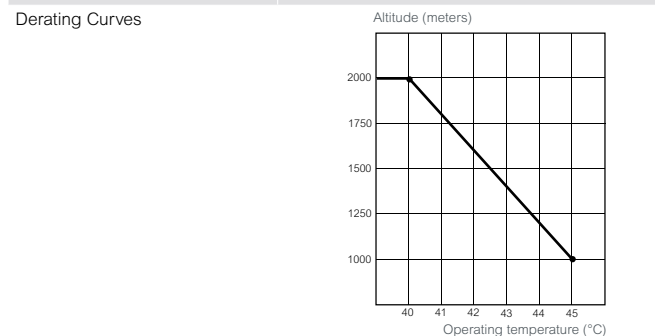

Display	
Technology	TFT
Size	1.4" diagonal (35.56mm)
Messages	Configuration, Monitoring and Diagnostics

Communications	
Connection	Dual port Ethernet - RJ45 connected to internal Ethernet switch, except if EtherCAT option (slave controller only)
Protocols	Modbus TCP, EtherNet/IP, PROFINET or EtherCAT
Baud Rate	10/100 full or half duplex, except if EtherCAT option (100M full duplex only)

Additional Functions	
Standard	Counter, Logic & Math blocks, Linearization 16 points, Timer, Totalizer
Options	Energy counter, OEM security, Graphical wiring

Mechanical Details				
Unit	Height	Width	Depth	Weight
16 to 32A	129.2mm / 5.09in	51mm / 2.01in	136.2mm / 9.04in	0.8kg / 1.76lb
40 to 63A	129.2mm / 5.09in	72mm / 2.83in	173.3mm / 9.04in	0.95kg / 2.09lb
80 to 100A	197.6mm / 7.78in	80mm / 3.15in	202.1mm / 9.04in	1.8kg / 3.97lb
125A	197.6mm / 7.78in	120mm / 4.72in	202.1mm / 9.04in	2.5kg / 5.51lb

Fuses		
Current Rating	Fuse Holder Size	Dimensions H x W x D
≤25A without MS	10x38mm / 13/32x1-1/2in	88.5x17.5x64.5mm / 3.48x0.69x2.54in
≤25A with MS	14x51mm / 9/16x2in	110.8x26.5x76.5mm / 4.36x1.04x3.01in
32A with or without MS	14x51mm / 9/16x2in	110.8x26.5x76.5mm / 4.36x1.04x3.01in
40A with or without MS	14x51mm / 9/16x2in	110.8x26.5x76.5mm / 4.36x1.04x3.01in
50A with or without MS	22x58mm / 2-9/32in	127.5x35x76.5mm / 5.02x1.38x3.01in
63A with or without MS	27x60mm / 1-1/16x2-3/8in	149.4x40x93.5mm / 5.88x1.57x3.68in
80A with or without MS	27x60mm / 1-1/16x2-3/8in	149.4x40x93.5mm / 5.88x1.57x3.68in
100A with or without MS	27x60mm / 1-1/16x2-3/8in	149.4x40x93.5mm / 5.88x1.57x3.68in
125A with or without MS	27x60mm / 1-1/16x2-3/8in	149.4x40x93.5mm / 5.88x1.57x3.68in

Power	
Nominal Current	4 to 125 amps
Nominal Voltage	100 to 500Vac +10%/-15%
Accuracy	±2% of full scale - from 100 to 500V +10%/-15%
Frequency	47Hz to 63Hz
Short Circuit Protection	By external supplemental high speed fuses
Rated Conditional Short-circuit Current	100kA (Coordination Type 1)
Utilization categories	AC51: Non-inductive or slightly inductive loads, resistance furnaces (cos phi >0.85 for Inom=>32A) AC-56a: Transformer Primary
Heater type	Low/high temperature coefficient and non-aging/aging types: MOSI Molybdenum Silicide, Silicon Carbide, Carbon.

Control	
Auxiliary Power Supply	100V to 500V +10%/-15% or 24 ac/dc (±20%)
Control Setpoint	Analog or Logic input or Digital Comms
Analogue Input Signal	
Voltage	Range: 0-5V, 1-5 V, 0-10V or 2-10V Impedance: 140 k Ohms typical (0-10V signal)
Current	Range: 0-20mA or 4-20mA Input resistance: 100 ohms to allow for three units wired in series to be driven from a single controller's analogue output
Resolution	11 bits
Linearity	±0.1% of Scale
Firing Mode	Phase angle, Intelligent Half cycle, Variable Modulation Burst firing (default 16 cycles), Fix modulation period (default 2 seconds), Logic mode
Control Mode	V ² control, I ² control, True Power control, Open loop with feedforward and Trim modes, Current limitation by threshold or by transfer V ² <-> I ² or P<-> I ²
Configurable Digital Inputs	Input 1: enable by default; Input 2: setpoint, alarm acknowledgment, 10V supply, ...
Voltage Inputs	PLC compatible inputs type 1 & 2 according to IEC 61131-2 - Active level (high): 11V<Vin<30V with 6mA<Iin<30mA - Non-active level (low): -3V<Vin<5V with 2mA<Iin<30mA or 5V<Vin<11V with Iin<2mA
Contact Closure Inputs	- Current source: 10mA min; 15mA max - Open contact (non active) resistance: 800 Ohms to ∞ - Closed contact (active) resistance: 0 to 450 Ohms - Absolute Maximum ±30V or ±25mA
One Alarm Relay	Changeover relay 2A rms - 264V rms normally energised. (250V rms max for UL). This relay will be de-energised in case of serious alarms: short circuit thyristor, open circuit, fuse blown, missing main, chop off

Mechanical Details

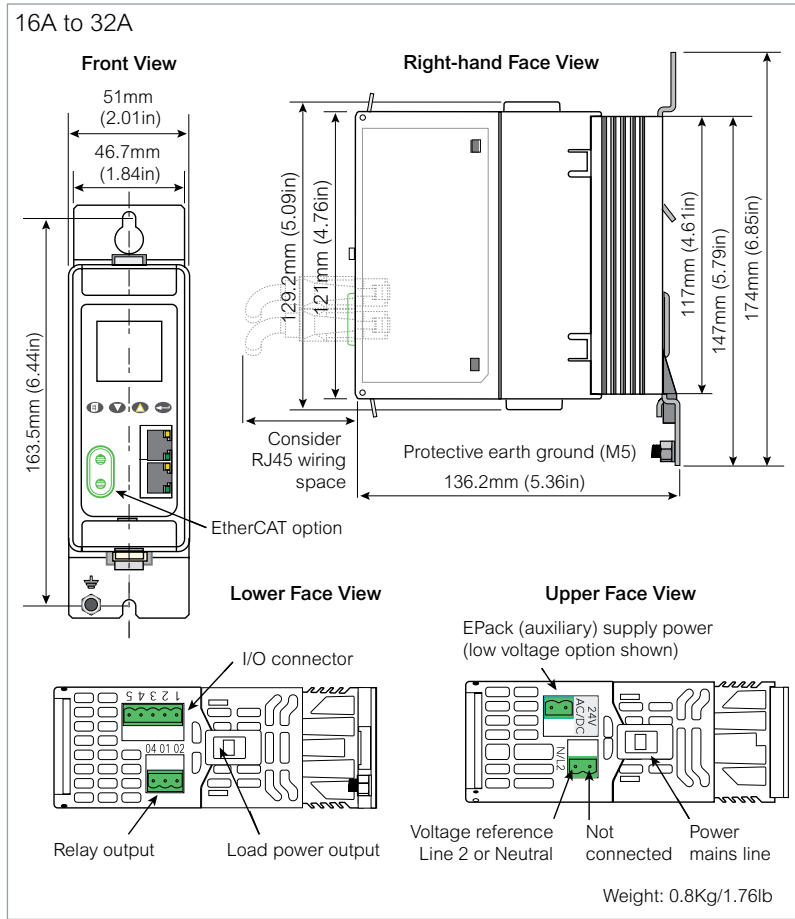

Connector Details (pinout)

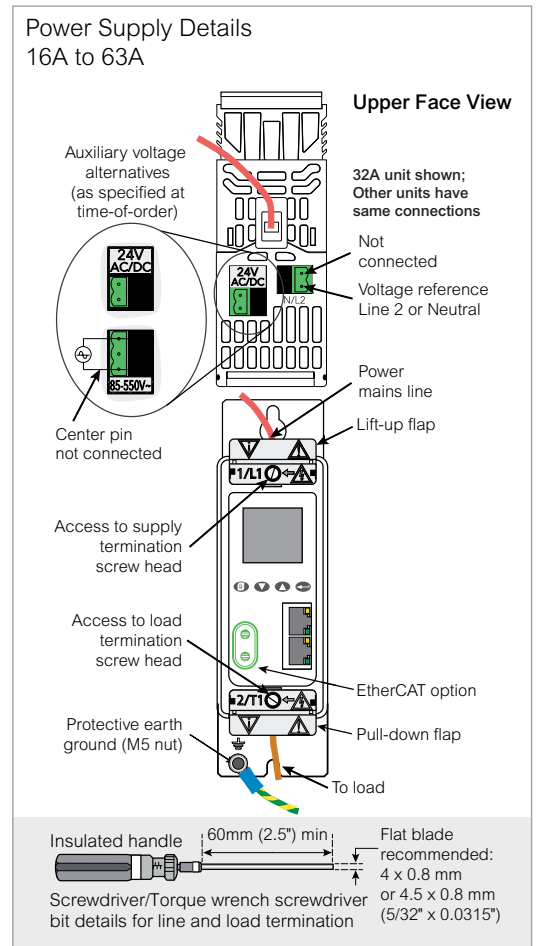
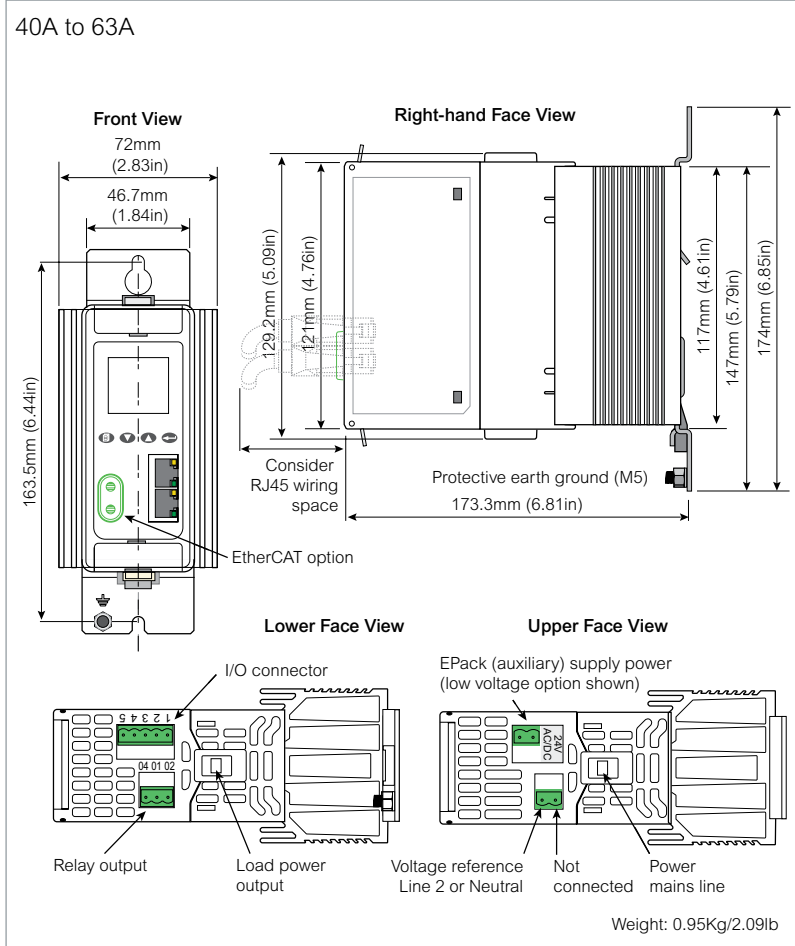
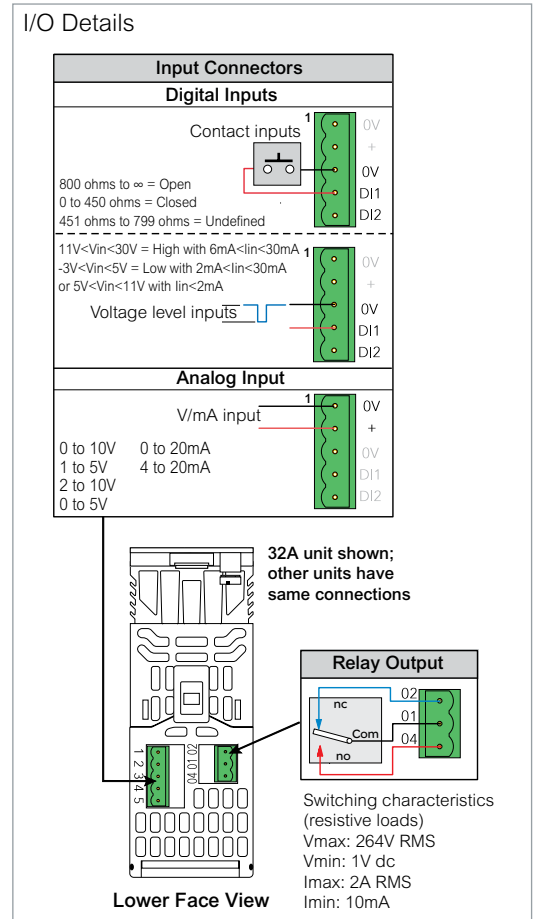

Mechanical Details

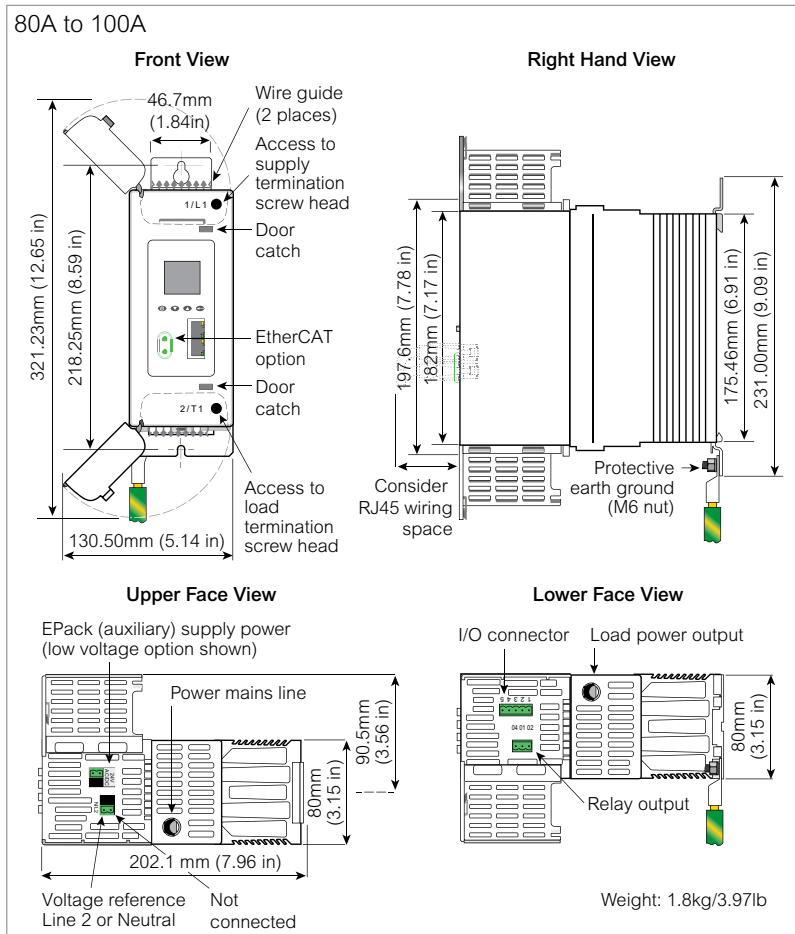

Connector Details (pinout)

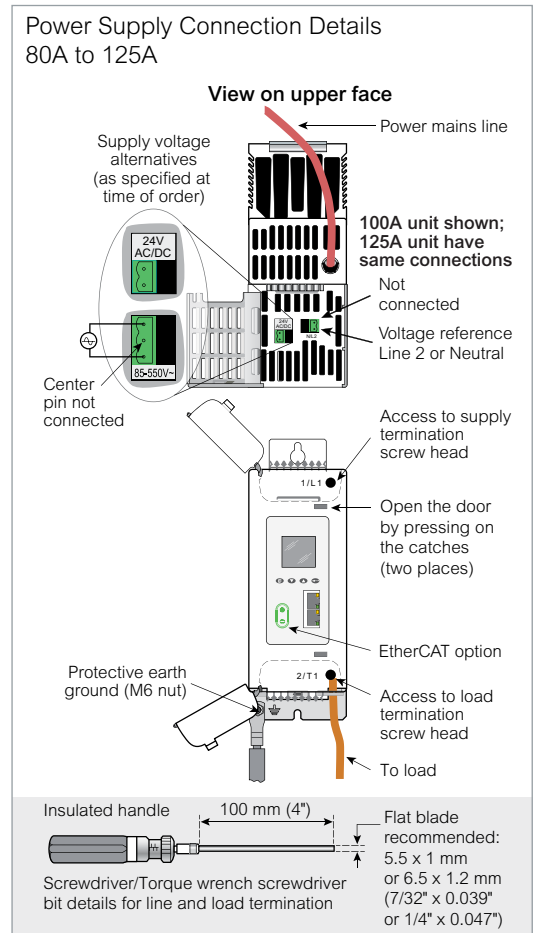
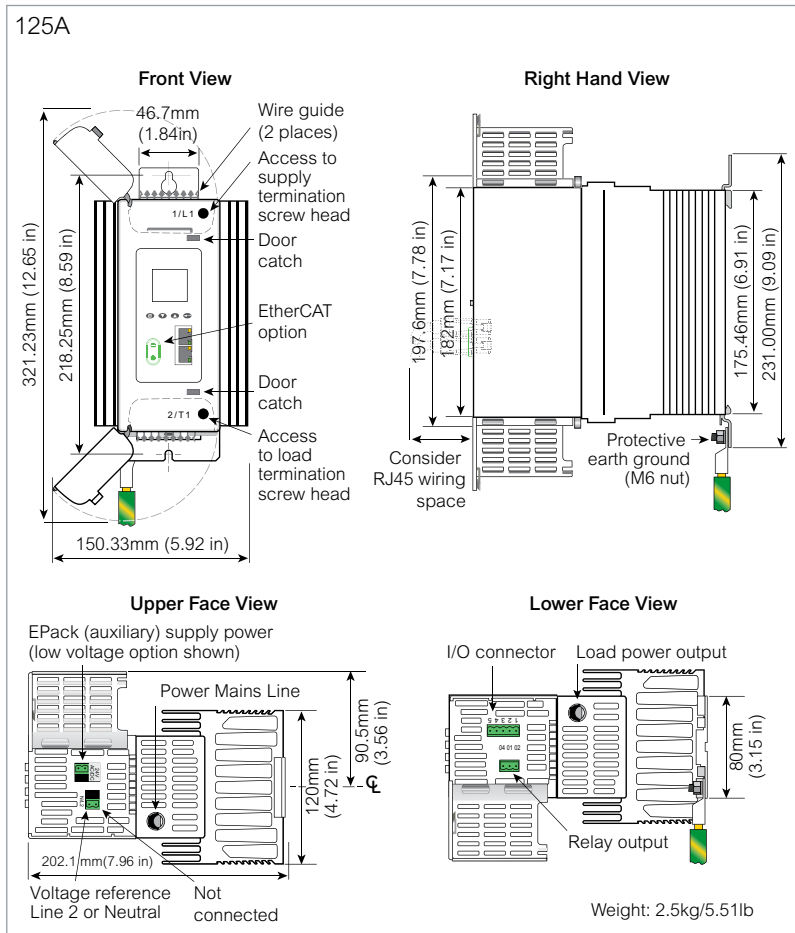
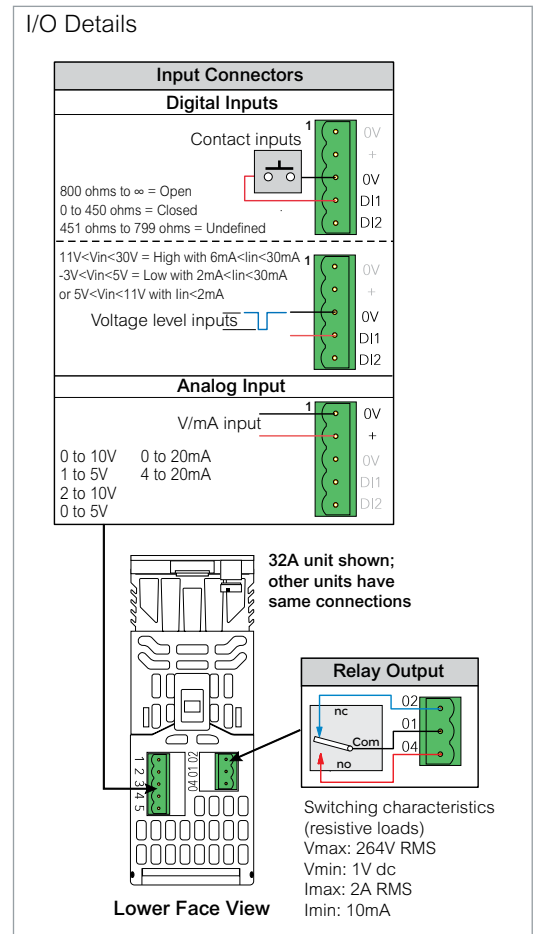

Order Codes

The EPack power controller is ordered using a short code for the chargeable options and an extended option configuration code for commissioning.

If the extended code is not used, the software configuration is completed using a quick start procedure or Eurotherm iTools software.

EPack controllers may be upgraded with additional chargeable options at any time using a software key order code.

Product Coding

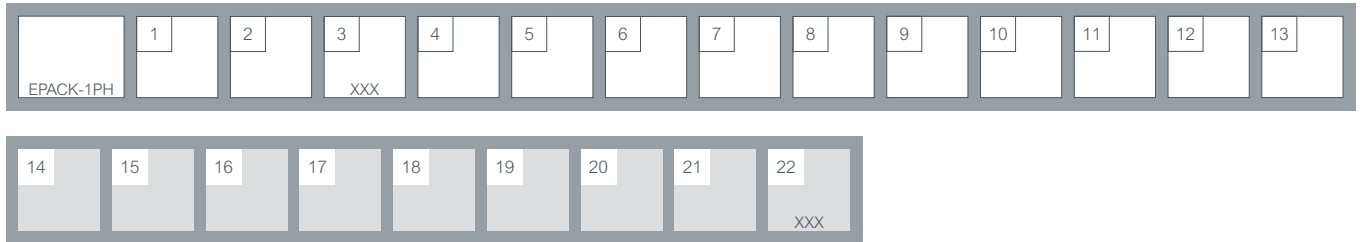

Model	
EPACK-1PH	Power Controller

1 Maximum Current	
16A	16 amps
25A	25 amps
32A	32 amps
40A	40 amps
50A	50 amps
63A	63 amps
80A	80 amps
100A	100 amps
125A	125 amps

2 Auxiliary Power Supply ^{note}	
500V	500V max
24V	24V ac/dc

3 Reserved	
XXX	Reserved

4 Control Option	
V2	V ² control
I2	I ² control
V2CL	V ² with current limitation by threshold
PWRCL	Power control with current limit

5 Transfer Option	
XXX	No Transfer
TFR	I ² Transfer

6 Energy Option	
XXX	None
EMS	Energy measurement

7 Comms Option	
TCP	Modbus TCP (standard)
IP	EtherNet/IP
PN	PROFINET
CAT ^{note}	EtherCAT

8 OEM Security	
XXX	No OEM Security
OEM	OEM Security

9 Warranty	
XXXXXX	Standard Warranty
WL005	5 Year Warranty
USWL3	US Extended Warranty

10 Custom Labelling	
XXXXXX	Standard (Eurotherm)
FXXXX	Special Label

11 Graphical Wiring	
XXX	No Graphical Wiring Edition
GWE	Graphical Wiring Editor

12 Fuse	
XXX	Without fuse
HSP	High speed fuse without microswitch
HSM	High speed fuse with microswitch

13 Configuration	
XXXXXX	Default
LC	Long code
EEnnn	Customer clone number

Optional Configuration

14 Nominal Load Current	
NNNA	1 - Value field 1

15 Nominal Line Voltage	
100V	100 volts
110V	110 volts
115V	115 volts
120V	120 volts
127V	127 volts
200V	200 volts
208V	208 volts
220V	220 volts
230V	230 volts
240V	240 volts
277V	277 volts
380V	380 volts
400V	400 volts
415V	415 volts
440V	440 volts
460V	460 volts
480V	480 volts
500V	500 volts

16 Load Type	
XX	Resistive
TR	Transformer primary

17 Heater Type	
XX	Resistive
MOSI	Molybdenum
CSI	Silicon Carbide
SWIR	Short Wave Infra-Red

18 Firing Mode	
PA	Phase angle
IHC	Intelligent half cycle
BF	Variable Modulation Burst firing (default 16 cycles)
FX	Fixed modulation period (default 2 seconds)
LGC	Logic mode

19 Analog Input Function	
XX	None
SP	Setpoint
HR	Setpoint limit
IL	Current limit
TS	Current transfer span

20 Analog Input Type	
0V	0-10 volts
1V	1-5 volts
2V	2-10 volts
5V	0-5 volts
0A	0-20 mA
4A	4-20mA

21 Digital Input 2 Function	
XX	None
LG	Setpoint for logic mode
AK	Alarm acknowledgement
RS	Remote setpoint selection
FB	Fuse blown
SU	10V supply

22 Reserved	
XXX	Reserved

^{note} Hardware variant, not available as software upgrade option

Software Upgrade Options



1 Serial Number Instrument	
Nnnn	Serial number

2 Current Ratings	
XXX	No change
16A-25A	Upgrade 16A to 25A
16A-32A	Upgrade 16A to 32A
25A-32A	Upgrade 25A to 32A
40A-50A	Upgrade 40A to 50A
40A-63A	Upgrade 40A to 63A
50A-63A	Upgrade 50A to 63A
80A-100A	Upgrade 80A to 100A

3 Control option	
XXX	No change
V2-V2CL	Upgrade V ² to V ² CL
V2-I2	Upgrade V ² to I ²
V2-PWRCL	Upgrade V ² to PWRCL
I2-V2CL	Upgrade I ² to V ² CL
V2CL-PWRCL	Upgrade V ² CL to PWRCL
I2-PWRCL	Upgrade I ² to PWRCL

4 Transfer Option	
XXX	No change
TFR	I ² Transfer

5 Energy Option	
XXX	No change
EMS	Energy measurement

6 Comms Option	
XXX	No change
IP	EtherNet/IP
PN	PROFINET

7 Graphical Wiring	
XXX	No change
GWE	Graphical wiring editor

8 OEM Security	
XXX	No change
OEM	OEM Security

eurotherm.com/epack

Life Is On

Schneider
Electric



Eurotherm Limited
Faraday Close, Durrington
Worthing, West Sussex, BN13 3PL
Phone: + 44 (0)1903 268500
www.eurotherm.com

Document Number HA031520 Issue 8

©2019 Schneider Electric. All Rights Reserved. Life Is On, Schneider Electric, EcoStruxure, Eurotherm, EurothermSuite, EFit, EPACK, EPower, Eycon, Eyrise, Chessell, Mini8, nanodac, optivis, piccolo and versadac are trademarks and property of Schneider Electric SE, its subsidiaries and affiliated companies. All other trademarks are the property of their respective owners.