

EPower™

MODEL



Power management and control units

Specification Sheet

- Fully software configurable
- Predictive Load Management
- Current rating 50A to 630A (nominal load 16A to 630A)
- Voltage up to 690V ac
- All types of firing modes
- Measurement accuracy <1%
- Large integral four row display
- Remote display option
- Multi-channel unit
- Event Log
- Optional I/O
- Modbus RTU comms
- Profibus DP comms
- DeviceNet® comms
- Ethernet (Modbus TCP) comms
- EtherNet/IP comms
- CC-Link comms
- Profinet IO comms
- Voltage, current and power control
- Complete diagnostics
- Energy counter
- Single phase Load Tap Changer

EPower™ is the Eurotherm® series of advanced power control units. Combining the advantages of the latest technologies and innovations to produce a truly impressive performance for your process.

Ratings

The EPower current ratings cover the range from 50 Amps up to 630 Amps (nominal 16 Amps to 630 Amps). Ratings are designed at 40°C, but operation can be defined up to 50°C with associated deratings. The voltage rating can go up to a maximum of 690 volts.

Predictive Load Management (Patented)

You can reduce your energy costs across your plant by using the Predictive Load Management functionality within EPower. This innovative feature provides a better distribution of energy across different loads in your installation by managing the priority and if necessary, load shedding.

Multi Channel Unit

EPower includes seven different power configurations within one unit, depending on the number of power modules fitted. From single phase configuration to two times two phase control, the unit is perfectly modular and configurable to your process requirements. Multiple zones can be controlled with one unit.

Many more features are available (Log file management, advanced alarm strategy, optional I/O...) to provide you with the best of the technology for your process.

Display and Remote Display

EPower is fitted with a 4 line x 10 character display with indication of the process values, and diagnostic information, along with an alarm and event message centre. Optionally, the EPower has a 32h8e remote display to allow for the process values and alarm information to be presented front of panel in a clear and unambiguous way. Secure access to the local setpoint is also provided to allow for local control when needed. The remote display, as an indicator, can also provide over temperature policeman functionality removing the need

imagine having the power to save energy

Communication

Eurotherm has an approach to open communications, offering standard fieldbus networks such as Modbus RTU, Profibus DP, DeviceNet®, Ethernet (Modbus TCP), EtherNet/IP, CC-Link and Profinet IO communications.. The use of Fieldbus makes integration into PLCs and other supervisory systems easy to accomplish. It allows an easier integration into PLCs and other supervisory systems by using the main protocols of the market.

Configuration

“Quick Start” HMI menus provide an easy and friendly way to quickly configure the unit. With the more complex configurations using the iTools software package.



Power module

Number of modules: Up to four identical units per Driver Module
 Voltage range: 100 to 600V ac (+10% - 15%) or 100 to 690V ac (+10% - 15%) as specified at time of order
 Frequency range: 47 to 63Hz
 Nominal current: 16 to 630A depending on power module
 Power dissipation: 1.3W per Amp per phase
 Rated short-circuit conditional current: CE Rated. 92kA all modules except: 98kA for 500A modules; 105kA for 630A modules.
 Note: this is not a UL508A test

Cooling

Up to and including 100A: Natural convection
 Above 100A: Fan cooling. Fans are connected in parallel to driver module connector
 Fan supply voltage: 115 or 230V ac, as specified at time of order (see 'Caution' above)
 Fan power requirement: 10W for 160A/250A modules; 15W for 400A, 500 and 630A modules

Protection Thyristor drive: RC circuits and high-speed fuses
 Pollution degree: Pollution degree 2 (EN60947-1)
 Installation category

Power network: Installation category III up to 600V; Installation category II up to 690V
 Auxiliary (fan) supply: Installation category II assuming nominal phase voltage with respect to earth is ≤300V rms

Utilisation categories AC51: non inductive or slightly inductive loads, resistance furnaces
 AC56a: switching of transformers
 Duty cycle: Uninterrupted duty/continuous operation
 Form designation: Form 4

Short circuit protection

co-ordination type: Type1 (fuses)

Load types: Single or multiphase control of resistive loads (low/high temperature coefficient and non-aging/aging types) and transformer primaries. Load voltage/current feedback either internal (standard) or external (option for use with transformer secondaries for example)

General specification

General Standards

The product is designed and produced to comply with EN60947-4-3 (Low voltage switch gear and control gear). Other applicable standards are cited where appropriate.

Installation Categories

General installation category details for the driver and power units are summarised in the table below.

	Installation Category	Rated impulse withstand voltage (Uimp)	Rated insulation voltage
Communications	II	0.5kV	50V
Standard I/O	II	0.5kV	50V
Driver module power	II	2.5kV	230V
Relays	III	4kV	230V
Power Modules (up to 600V)	III	6kV	600V
Power Modules (690V)	II	6kV	690V
Auxiliary (Fan) supply	II	2.5kV	230V

Table 1 Installation category details

Power (at 40°C)

Caution

Although the driver module supply voltage range is 85 to 265V ac, the fans (if any) fitted to the power (thyristor) modules are specified for use at one of 115V ac or 230V ac as specified at time of order. Before plugging the fan harness into the driver module, ensure that the utility supply voltage is suitable for the fan(s). Otherwise, fan life may be shortened or the cooling effect may not be sufficient, either case presenting a possible hazard to the equipment or to the operator.

Driver module

Voltage range: 100 to 240V ac (+10% - 15%)
 Frequency range: 47 to 63Hz
 Power requirement: 60W + Power Module fans (15W each for 400A/500A/630A power modules; 10W each for 160A/250A modules)

Installation Category Installation category II (category III for relays)

Physical

Dimensions and fixing centres: See Fixing Details

Weight: See Table 2 (weights ± 50gm (2oz))

Current	Weight (including 2kg (4.4lb) for driver module)			
	1 phase	2 phases	3 phases	4 phases
50A/100A	6.5 (14.3)	11.0 (24.3)	15.5 (34.2)	20.0 (44.1)
160A	6.9 (15.2)	11.8 (26.0)	16.7 (36.8)	21.6 (47.6)
250A	7.8 (17.2)	13.6 (30.0)	19.4 (42.8)	25.2 (55.6)
400A	11.8 (26.0)	21.6 (47.6)	31.4 (69.2)	41.2 (90.8)
500A	14.0 (30.9)	26.0 (57.3)	38.0 (83.8)	50.0 (110.2)
630A	14.5 (32.0)	27.0 (59.5)	39.5 (87.1)	52.0 (114.6)

Table 2 Weights

	lb	oz
	0.1	1.6
	0.2	3.2
	0.3	4.8
	0.4	6.4
	0.5	8.0
	0.6	9.6
	0.7	11.2
	0.8	12.8
	0.9	14.4

Environment

Temperature limits Operating: 0°C to 50°C (derate above 40°C as per accompanying curves)

Storage: -25°C to 70°C

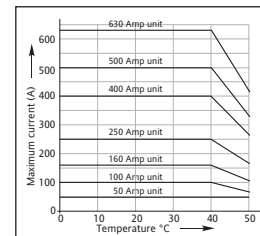

Humidity limits: 5% to 95% RH (non-condensing)

Altitude (maximum): 1000 metres

Protection: IP10 (EN60529)

Atmosphere: Non-explosive, non-corrosive and non-conductive

External wiring: Must comply with IEC 364

Shock (EN60068-2-29): 10g Peak; 6ms duration; 100 bumps

Vibration (EN60068-2-6): 67-150Hz at 1g

EMC

Standard: EN60947-4-3 Emissions class A
This product has been designed for environment A (Industrial). Use of this product in environment B (domestic, commercial and light industrial) may cause unwanted electromagnetic disturbances in which cases the user may be required to take adequate mitigation measures.

Immunity criteria: Immunity criterion 1 (criterion 3 for voltage dips and short-time interruptions)

Operator Interface

Display: 4 lines of up to 10 characters each. Display pages can be used to view process variable values and to view and edit the configuration of the unit. (Editing of the configuration is better carried out using configuration software (iTools). In addition to the standard displays, up to four 'custom' pages can be defined which allow bargraph displays, text entry etc.

Character format: 7 high x 5 wide yellow-green LCD dot matrix array

Push buttons: 4 push buttons provide page and item entry and scroll facilities

LED indicators (beacons): 3 indicators (PWR LOC and ALM) are supplied to indicate that power is applied, that Local Control is selected and that there is one or more active alarm respectively

Standard Inputs/Outputs (SK1)

All figures are with respect to driver module 0V, unless otherwise stated.

Number of inputs/outputs

No of analogue inputs: 2

No of analogue outputs: 1

No of digital inputs/outputs: 2 (each configurable as an input or an output)

10V (Potentiometer) supply: 1

Update rate: Twice the mains frequency applied to power module 1. Defaults to 83.2Hz (12ms) if no power applied to power module1 or if supply frequency lies outside the range 47 to 63Hz)

Termination: Removable 10-way connector. (5.08 mm. pitch)

Analogue Inputs

Performance: See Tables 3 and 4

Input types: Each input is configurable as one of: 0 to 10V, 1 to 5V, 2 to 10V, 0 to 5V, 0 to 20mA, 4 to 20 mA

Absolute maxima + terminal: $\pm 16V$ or $\pm 40mA$
- terminal: $\pm 1.5V$ or $\pm 300mA$

Analogue outputs

Performance: See Tables 5 and 6

Output types: Each output is configurable as one of 0 to 10V, 1 to 5V, 2 to 10V, 0 to 5V, 0 to 20mA, 4 to 20 mA

Absolute maxima + terminal: (-0.7V or -300mA) or (+16V or +40mA)
0V terminal: $\pm 2A$

Analogue input: Voltage input performance		
Parameter	Typical	Max/Min
Total voltage working input span (Note 1)		-0.25V to +12.5V
Resolution (noise free) (Note 2)	13 bits	
Calibration error (Notes 3 and 4)	<0.25%	<0.5%
Linearity error (Note 3)		$\pm 0.1\%$
Ambient temperature error (Note 3)		<0.01%/°C
Input resistance (+ve terminal to 0V)		>140k Ω
Input resistance (-ve terminal to 0V)	150 Ω	
Allowable voltage (-ve terminal to 0V)		$\pm 1V$
Series mode rejection of mains interference	46dB	>30dB
Common mode dc rejection	46dB	>40dB
Hardware response time	5ms	
Note 1: w.r.t. to the relevant -ve input		
Note 2: w.r.t. total working span		
Note 3: % of effective range (0 to 5V, 0 to 10V)		
Note 4: After warm up. Ambient = 25°C		

Table 3 Analogue input specification table (voltage inputs)

Analogue input: Current input performance		
Parameter	Typical	Max/Min
Total current working input span		-1mA to +25mA
Resolution (noise free) (Note 1)	12 bits	
Calibration error (Notes 2 and 3)	<0.25%	<0.5%
Linearity error (Note 2)		$\pm 0.1\%$
Ambient temperature error (Note 2)		<0.01%/°C
Input resistance (+ve to -ve terminal)	235 Ω	
Input resistance (-ve terminal to 0V)	150 Ω	
Allowable voltage (-ve terminal to 0V)		< $\pm 1V$
Series mode rejection of mains interference	46dB	>30dB
Common mode dc rejection	46dB	>40dB
Hardware response time	5ms	
Note 1: w.r.t. total working span		
Note 2: % of effective range (0 to 20mA)		
Note 3: After warm up. Ambient = 25°C		

Table 4 Analogue input specification table (current inputs)

Analogue output: Voltage output performance		
Parameter	Typical	Max/Min
Total voltage working span (within $\pm 20mA$ (typ.) current span)		-0.5V to +12.5V
Short circuit current		<24mA
Resolution (noise free) (Note 1)	12.5 bits	
Calibration error (Notes 2 and 3)	<0.25%	<0.5%
Linearity error (Note 2)		< $\pm 0.1\%$
Ambient temperature error (Note 2)		<0.01%/°C
Minimum load resistance		>800 Ω
DC output impedance		<2 Ω
Hardware response time (10% to 90%)	20ms	<25ms
Note 1: w.r.t. total working span		
Note 2: % of effective range (0 to 5V, 0 to 10V)		
Note 3: After warm up. Ambient = 25°C		

Table 5 Analogue output specification table (voltage outputs)

Analogue output: Current output performance		
Parameter	Typical	Max/Min
Total current working span (within -0.3V to +12.5V voltage span)		-24mA to +24mA
Open circuit voltage		<16V
Resolution (noise free) (Note 1)	12.5 bits	
Calibration error (Notes 2 and 3)	<0.25%	<0.5%
Linearity error (Note 2)		< $\pm 0.1\%$
Ambient temperature error (Note 2)		<0.01%/°C
Maximum load resistance		<550 Ω
DC Output conductance		<1 $\mu A/V$
Hardware response time (10% to 90%)	20ms	<25ms
Note 1: w.r.t. total working span		
Note 2: % of effective range (0 to 20mA)		
Note 3: After warm up. Ambient = 25°C		

Table 6 Analogue output specification table (current outputs)

10V supply (Potentiometer supply)

Output voltage: 10.0V \pm 0.3V @ 5.5mA

Short circuit o/p current: 15mA max.

Ambient temperature drift: $\pm 0.012\%/^{\circ}C$ (typ); $\pm 0.04\%/^{\circ}C$ (max.)

Absolute maxima Pin 1: (-0.7V or -300mA) or (+16V or +40mA)

Digital I/O

Hardware response time: 100 μs

Voltage inputs

Active level (high): 4.4V < Vin < 30V

Non-active level (low): -30V < Vin < +2.3V

Input impedance: 10k Ω

Contact closure inputs

Source current: 10mA min; 15mA max

Open contact

(non active) resistance: >500 Ω

Closed contact

(active) resistance: <150 Ω

Current source output

Source current: 9mA < I_{source} < 14mA @ 14V

10mA < I_{source} < 15mA @ 0V

9mA < I_{source} < 14mA @ -15V

Open circuit voltage: <14V

Internal pull-down resistance: 10k Ω (to 0V)

Absolute maxima + terminal: $\pm 30V$ or $\pm 25mA$

0V terminal: $\pm 2A$

Notes:

1. Absolute maximum ratings refer to externally applied signals
2. The 10V potentiometer supply is designed to supply two 5k Ω potentiometers connected in parallel with one another.
3. The maximum current for any 0V terminal is $\pm 2A$.

Relay Specification

The relays associated with this product have gold plated contacts applicable to 'dry circuit' (low current) use.

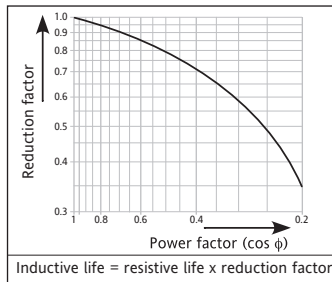

Contact life	Resistive loads:	100,000 operations (de-rate with inductive loads as per figure)
High power use	Current:	<2A (resistive loads)
	Voltage:	<264V RMS
Low power use	Current:	>1mA
	Voltage:	>1V
Contact configuration:		Single pole change-over (One set of Common, Normally Open and Normally Closed contacts)
Termination Relay 1 (standard):		3-way connector on underside of driver module
Watchdog relay (standard):		3-way connector on underside of driver module
Relays two to four (option):		12-way option module connector
Installation Category		Installation category III, assuming that nominal phase to earth voltage is ≤300V RMS. Isolation between different relays' contacts is double isolation, in accordance with the installation category and phase to earth voltage specified above.
Absolute max switching capability:		<2A at 240V RMS (resistive loads)

Note: Normally closed and normally open refer to the relay when the coil is not energised.

Optional Input/Output Modules (SK3, SK4, SK5)

Up to three input/output modules can be fitted, each containing the inputs and outputs detailed below. Unless otherwise stated below, the specification for the optional I/O (including relays) is as given above for the standard I/O.

Termination:	Removable 12-way (5.08mm pitch) connector per module
Number of modules:	Up to 3
Number of inputs:	1 analogue input and 2 digital inputs per module
Number of outputs:	1 analogue output per module
Number of relays:	1 set of common, normally open and normally closed contacts per module
10V potentiometer supply output voltage:	10.0V ±0.3V at 5.5mA

Mains Network Measurements

All network measurements are calculated over a full mains cycle, but internally updated every half-cycle. For this reason, power control, current limits and alarms all run at the mains half-cycle rate. The calculations are based on waveform samples taken at a rate of 20kHz. Measurements on each phase are synchronised to its own phase and if the line voltage cannot be detected, the measurements stop for that phase. It should be noted that, depending on the configuration, the phase voltage referred to is one of:

- the line voltage referenced to neutral in four star,
- the line voltage referenced to neutral or another phase for single phase networks or
- the line voltage referenced to the phase applied to the next adjacent power module for three phase star or delta networks.

The parameters below are directly derived from measurements for each phase.

Accuracy (20 to 25°C)	
Line RMS voltage (Vline):	±0.5% of Nominal Vline
Load RMS voltage (V):	±0.5% of Nominal V for voltage readings >1% of Nominal V. Unspecified for readings lower than 1%Vnom
Thyristor RMS current (IRMS):	±0.5% of Nominal IRMS for current readings >3.3% of Nominal IRMS. Unspecified for readings = 3.3% Nominal IRMS
Note:	For external current feedback the above specification does not include errors associated with external current transformers.
Load RMS voltage squared (Vsqr):	±1% of (Nominal V) ²
Thyristor RMS current squared (Isqr):	±1% of (Nominal I) ²
True load power (P):	±1% of (Nominal V) x (Nominal I)
Frequency resolution:	0.1Hz
Measurement resolution:	11 bits of Nominal value (noise free)
Meas. drift with ambient temp:	<0.02% of reading /°C

Further parameters (S, PF, Q, Z, Iavg, IsqBurst, IsqMax, Vavg, Vsqr Burst, VsqrMax and PBurst) are derived from the above, for each network (if relevant). See EPower User Guide Section (Meas submenu) for further details.

External Current Transformer

Ratio:	Chosen such that the full scale output from the current transformer is 5 Amps
--------	---

Communications

CC-Link	Protocol:	CC-Link version 1.1
	Connector:	5-way
	Indicators:	RUN and ERR
DeviceNet	Protocol:	DeviceNet
	Connector:	5-way
	Indicators:	Network status and Module status
EtherNet	Type:	10baseT (IEEE801)
	Protocol:	Modbus TCP
	Connector:	RJ45
	Indicators:	Tx activity (green) and communications activity (yellow)
EtherNet/IP	Protocol:	EtherNet/IP
	Connector:	RJ45
	Indicators:	NS (Network status), MS (Module status) and LINK (Link status)
Modbus RTU	Protocol:	Modbus RTU slave
	Transmission standard:	3-wire EIA485
	Connector:	Twin, parallel-wired RJ45
	Indicators:	Tx activity (green) and Rx activity (yellow)
	Isolation (EN60947-4-3):	Installation category II, Pollution degree 2
	Terminals to ground:	50V RMS or dc to ground (double isolation)
Profibus	Protocol:	Profibus DPV1
	Connector:	9-way D-type
	Indicators:	Mode and Status
Profinet	Protocol:	Profinet IO
	Connector:	RJ45
	Indicators:	NS (Network status), MS (Module status) and LINK (Link status).

Electrical Installation

Drive Module Connectors

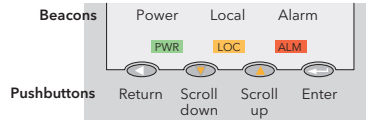
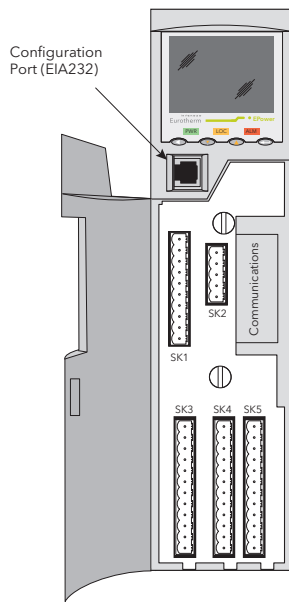

SK1 Standard I/O

1	+10 Volts out
2	Analogue i/p 1 +
3	Analogue i/p 1 -
4	Analogue i/p 2 +
5	Analogue i/p 2 -
6	Analogue o/p 1 +
7	Analogue o/p 1 0V
8	Digital i/o 1+
9	Digital i/o 2+
10	Digital i/o 0V

SK2 Predictive Load Management Option

1	Terminator A
2	Low
3	Shield
4	High
5	Terminator B



■ = Polarising pin

SK3 Optional I/O 1

1	+10 Volts out
2	Analogue i/p 3 +
3	Analogue i/p 3 -
4	Analogue o/p 2 +
5	Analogue o/p 2 0V
6	Digital i/p 3 +
7	Digital i/p 4 +
8	Digital 0V
9	Not used
10	Relay 2 NO (24)
11	Relay 2 Com (21)
12	Relay 2 NC (22)

Polarising pins:
Fixed connector: pins 1 and 2;
Mating connector: pin 3

SK4 Optional I/O 2

1	+10 Volts out
2	Analogue i/p 4 +
3	Analogue i/p 4 -
4	Analogue o/p 3 +
5	Analogue o/p 3 0V
6	Digital i/p 5 +
7	Digital i/p 6 +
8	Digital 0V
9	Not used
10	Relay 3 NO (34)
11	Relay 3 Com (31)
12	Relay 3 NC (32)

Polarising pins:
Fixed connector: pins 2 and 3;
Mating connector: pin 1

SK5 Optional I/O 3

1	+10 Volts out
2	Analogue i/p 5 +
3	Analogue i/p 5 -
4	Analogue o/p 4 +
5	Analogue o/p 4 0V
6	Digital i/p 7 +
7	Digital i/p 8 +
8	Digital 0V
9	Not used
10	Relay 4 NO (44)
11	Relay 4 Com (41)
12	Relay 4 NC (42)

Polarising pins:
Fixed connector: pins 1 and 3;
Mating connector: pin 2

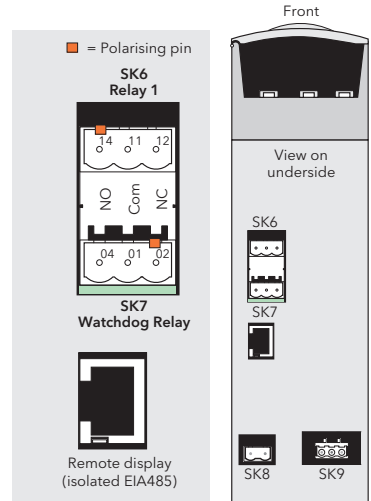
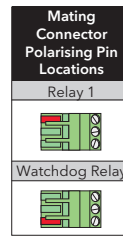

Safety Earth Details			
Max. load current	Minimum earth cable cross-section	Earth Terminal	
		Size	Tightening torque
50/100A	25 mm ²	M6	5 Nm (3.7 ft lb)
160A	35 mm ²	M6	5 Nm (3.7 ft lb)
250A	70 mm ²	M8	12.5 Nm (9.2 ft lb)
400A	120 mm ²	M10	15 Nm (11.1 ft lb)
500A	150 mm ²	M12	25 Nm (18.4 ft lb)
630A	185 mm ²	M12	25 Nm (18.4 ft lb)

Power Module Connectors

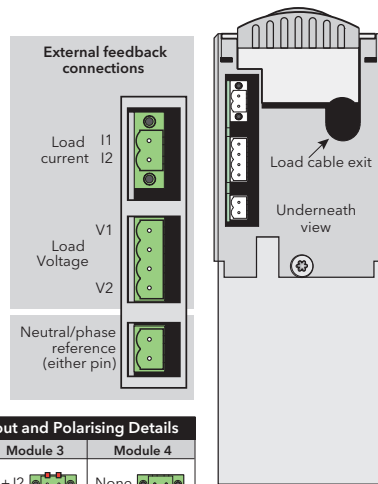

External Feedback Connector Pinout and Polarising Details

	Module 1	Module 2	Module 3	Module 4
Current external feedback connector	I2 I1	I1 I2	I1 + I2 None	None I1 + I2
Voltage external feedback connector	V1 V2	V2 V1	V1 + V2 None	None V1 + V2
Neutral/phase reference connector				

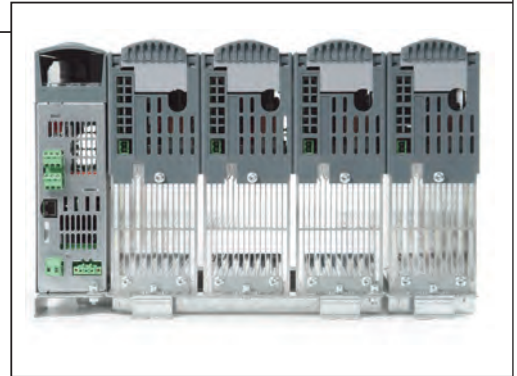

Line/Load Termination Details			
Max. load current	Terminal size	Minimum cable cross-section	Recommended torque setting
50/100A	M8	35 mm ²	12.5 Nm (9.2 ft lb)
160A	M8	70 mm ²	12.5 Nm (9.2 ft lb)
250A	M10	120 mm ²	25 Nm (18.4 ft lb)
400A	M12	240 mm ²	28.8 Nm (21.2 ft lb)
500A	2 x M12	2 x 150 mm ²	30 Nm (22.1 ft lb)
630A	2 x M12	2 x 185 mm ²	30 Nm (22.1 ft lb)

Communications

DeviceNet Connector Pinout

Pin	Function
1	V- (negative bus supply voltage)
2	CAN_L
3	Cable shield
4	CAN_H
5	V+ (positive bus supply voltage)

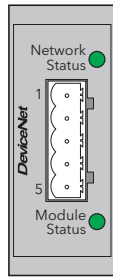

Network Status LED Indication	
LED state	Interpretation
Off	Off-line or no power
Steady green	On-line to 1 or more units
Flashing green	On-line - no connections
Steady red	Critical link failure
Flashing red	1 or more connections timed out

Module Status LED Indication	
LED state	Interpretation
Off	No power
Steady green	Operating normally
Flashing green	Missing or incomplete configuration
Steady red	Unrecoverable fault(s)
Flashing red	Recoverable fault(s)

- Notes:**
- See DeviceNet specification for power supply specification
 - During startup, an LED test is performed, satisfying the DeviceNet standard.

Modbus RTU Pinout

Pin	Signal (EIA485)
8	Reserved
7	Reserved
6	N/C
5	N/C
4	N/C
3	Isolated 0V
2	A
1	B

Internal connections:
 Pin 1 to 5V via 100k
 Pin 2 to 0V via 100k

LEDs:
 Green = Tx activity
 Yellow = Rx activity

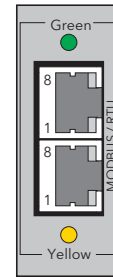

Connectors in parallel

Profibus Connector Pinout

Pin	Function	Pin	Function
9	N/C	5	Isolated ground
8	A (RxD-/TxD-)	4	RTS
7	N/C	3	B (RxD+/TxD+)
6	+5 V (1)	2	N/C
		1	N/C

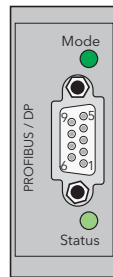

Operation Mode LED Indication	
LED state	Interpretation
Off	Off-line or no power
Steady green	On-line, data exchange
Flashing green	On-line, clear
Red single flash	Parametrisation error
Red double flash	Profibus configuration error

Status LED Indication	
LED state	Interpretation
Off	No power or not initialised
Steady green	Initialised
Flashing green	Diagnostic event present
Steady red	Exception error

- Notes:**
- Isolated 5 Volts for termination purposes. Any current drawn from this terminal affects the total power consumption.
 - The cable screen should be terminated to the connector housing.

Modbus TCP (Ethernet 10baseT) Pinout

Pin	Function
8	N/C
7	N/C
6	Rx-
5	N/C
4	N/C
3	Rx+
2	Tx-
1	Tx+

LEDs:
 Green = Tx activity
 Yellow = Network activity

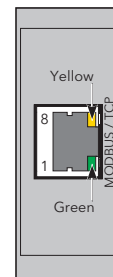

CC-Link Connector Pinout

Pin	Function
1	DA (Rx+/Tx+) — 110R, 1/2W, 5% across pins 1 and 2 of first and last connectors
2	DB (Rx-/Tx-)
3	DG (Signal ground)
4	SLD (Cable Shield) — SLD and FG connected internally
5	FG (Protective Ground)

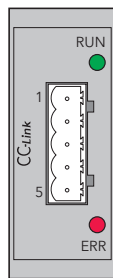

'RUN' LED Indication	
LED state	Interpretation
Off	Off-line or no power
Green	Normal operation
Red	Major fault (fatal error)

'ERR' LED Indication	
LED state	Interpretation
Off	No error or no power
Steady red	Exception or fatal event
Flickering red	CRC Error
Flashing red	Station number of Baud rate has changed since startup

- Notes:**
- A 110 Ohm ($\pm 5\%$ 1/2 watt) terminating resistor should be connected across pins 1 and 2 of the connectors at each end of the transmission line.
 - The cable shield should be connected to pin 4 of each CC-Link connector.
 - The shield and Protective earth terminals (pins 4 and 5) are internally connected.

EtherNet/IP Connector Pinout

Pin	Function
1	Tx+
2	Tx-
3	Rx+
4	N/C
5	N/C
6	Rx-
7	N/C
8	N/C

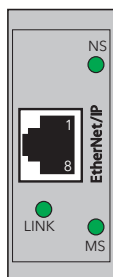

NS (Network Status) LED Indication	
LED state	Interpretation
Off	No power or no IP address
Steady green	On-line, one or more connections established (CIP class 1 or 3)
Flashing green	On-line, no connections enabled
Steady red	Duplicate IP address, ('fatal' error)
Flashing red	One or more connections timed out (CIP class 1 or 3)

MS (Module Status) LED Indication	
LED state	Interpretation
Off	No power
Steady green	Controlled by a scanner in Run state
Flashing green	Not configuration or scanner in idle state
Steady red	Major fault (Exception-state, fatal error etc.)
Flashing red	Recoverable fault

LINK LED Indication	
LED state	Interpretation
Off	No Link, no activity
Steady green	Link established
Flickering green	Activity in progress

Profinet IO Connector Pinout

Pin	Function
1	Tx+
2	Tx-
3	Rx+
4	N/C
5	N/C
6	Rx-
7	N/C
8	N/C



NS (Network status) LED	
LED state	Interpretation
Off	No power or no connection with I/O Controller
Steady green	On-line (RUN); connection with IO controller established. Controller in 'Run' state
Flashing green	On-line (STOP); connection with IO controller established. Controller in 'Stop' state

MS (Module status) LED		
LED state	Interpretation	
Off	Not initialised	No power or the module is in 'SETUP' or 'NW_INIT' state
Green steady	Normal operation	The module has shifted from the 'NW-INIT' state
Green 1 flash	Diagnostic event	One or more Diagnostic Event present
Green 2 flash	Blink	Used by engineering tools to identify the node on the network
Red steady	Exception error	The module is in 'EXCEPTION' state
Red 1 flash	Configuration error	The Expected Identification differs from the Real Identification
Red 2 flash	IP Address error	The IP address is not set
Red 3 flash	Station Name error	The Station Name is not set
Red 4 flash	Internal error	The module has encountered a major internal fault

LINK LED Indication	
LED state	Interpretation
Off	No Link, no activity
Steady green	Link established; no activity
Flickering green	Activity in progress

General diagrams

Caution

1. Neutral/phase reference connections (if applicable) must be located between any isolating device and the relevant Power Module.
2. For single phase configurations, all Neutral reference connections must be individually fused.

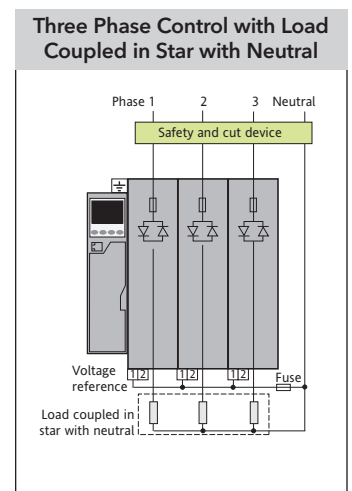
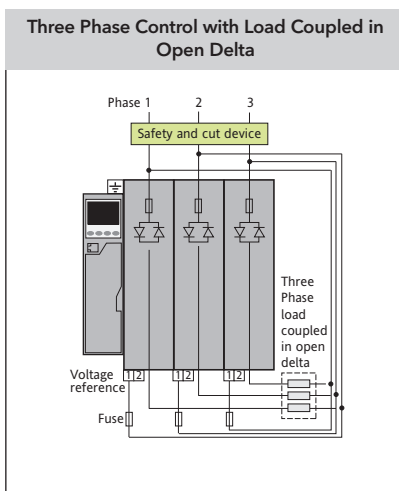
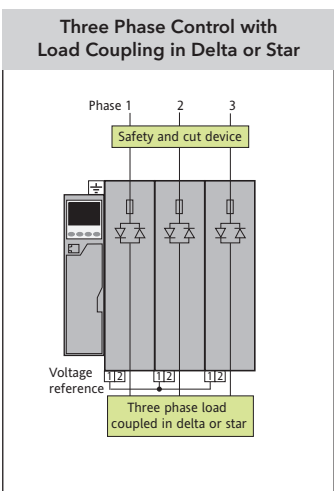
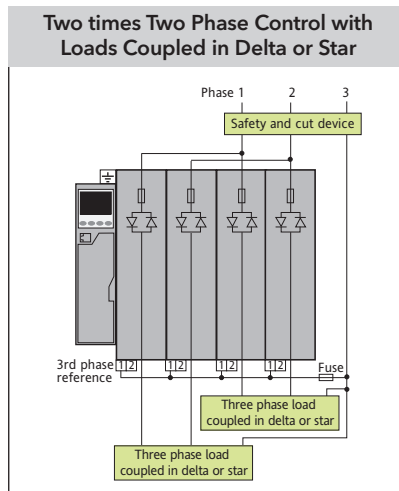
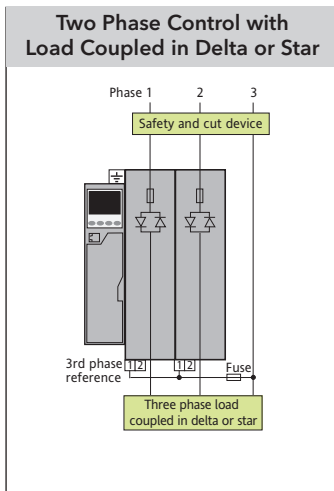
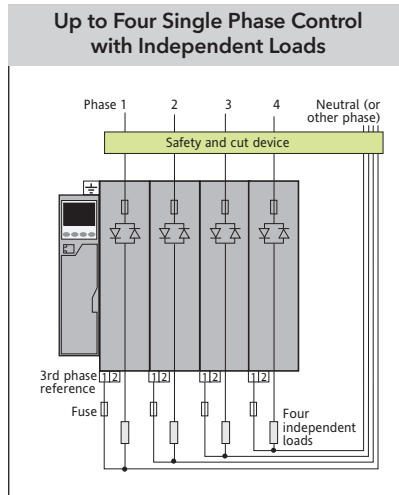
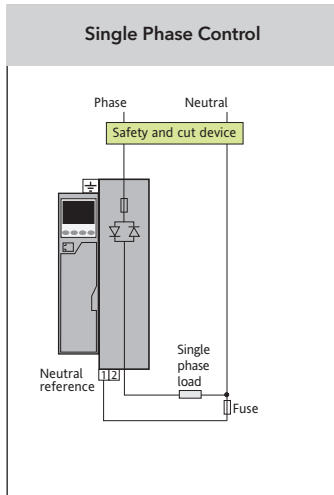

50A/100A (drawing on the right)
160A/250A (drawings next page)
Fixing Details

Note: Units are shown with individual mounting brackets. Multi-phase units come supplied with 2, 3 or 4 phase brackets as appropriate. See table below for details.

Dimension mm (inches)

50/100/160/250 AMPS	Overall Widths			
No of phases	1	2	3	4
Door closed	149.5 (5.89)	234.5 (9.23)	319.5 (12.58)	404.5 (15.93)
Door open	211.0 (8.31)	296.0 (11.65)	381.0 (15.00)	466.0 (18.35)

Bracket	Upper	Lower
2-phase	Use A & B	Use E & F
3-phase	Use A, B & C	Use E, F & G
4-phase	Use A, B, C & D	Use E, F, G & H

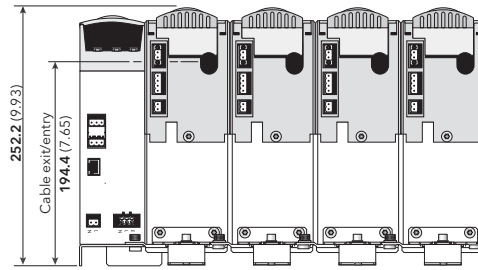
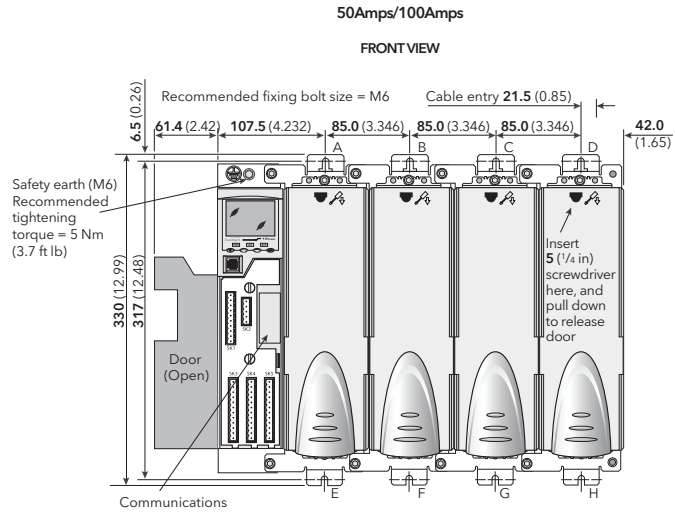

400A (drawing on the right)
500A/630A (drawing next page)
Fixing Details

Note: Units are shown with individual mounting brackets. Multi-phase units come supplied with 2, 3 or 4 phase brackets as appropriate. See table below for details.

Dimension mm (inches)

400/500/630AMPS	Overall Widths			
No of phases	1	2	3	4
Door closed	189.5 (7.46)	314.5 (12.38)	439.5 (17.30)	564.5 (22.22)
Door open	251.0 (9.88)	376.0 (14.80)	501.0 (19.72)	626.0 (24.65)

Bracket	Upper	Lower
2-phase	Use A & B	Use E & F
3-phase	Use A, B & C	Use E, F & G
4-phase	Use A, B, C & D	Use E, F, G & H

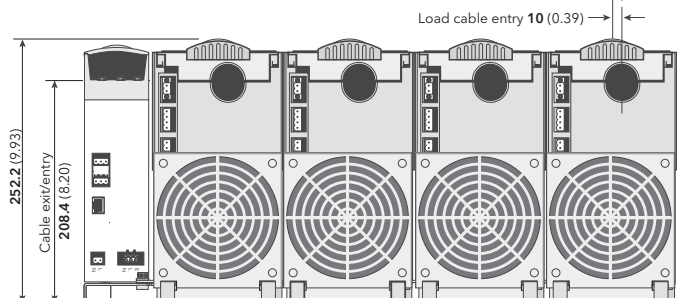
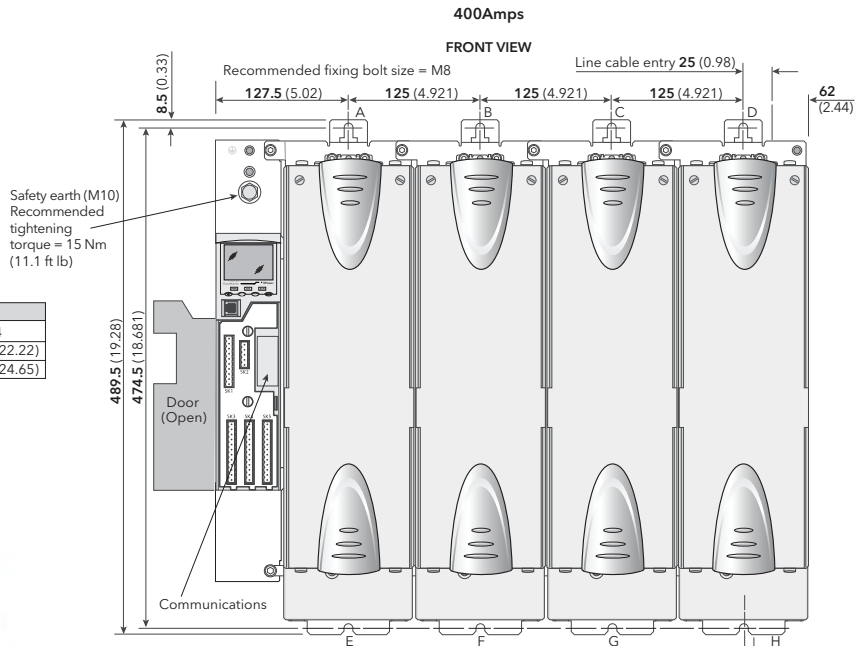

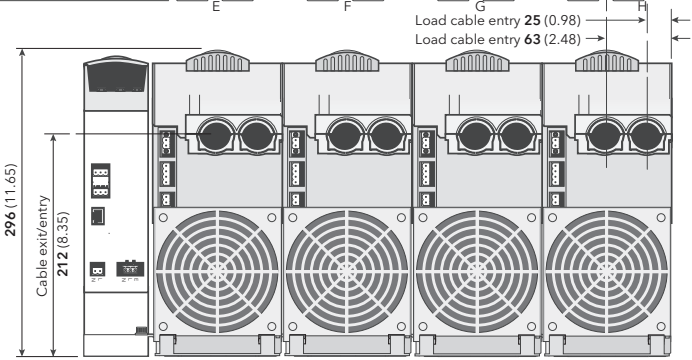
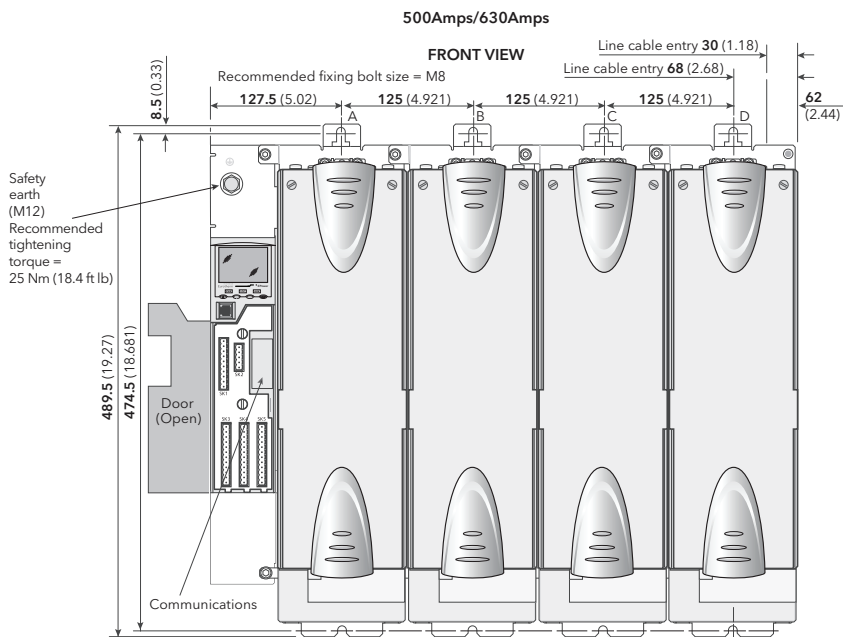
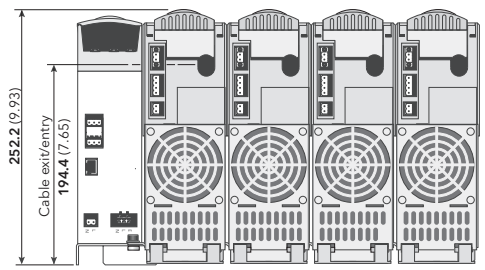
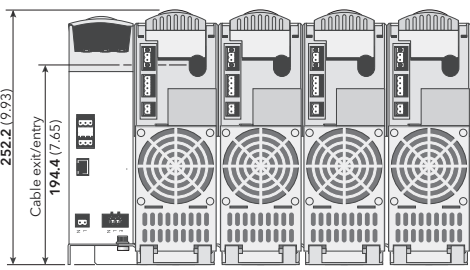
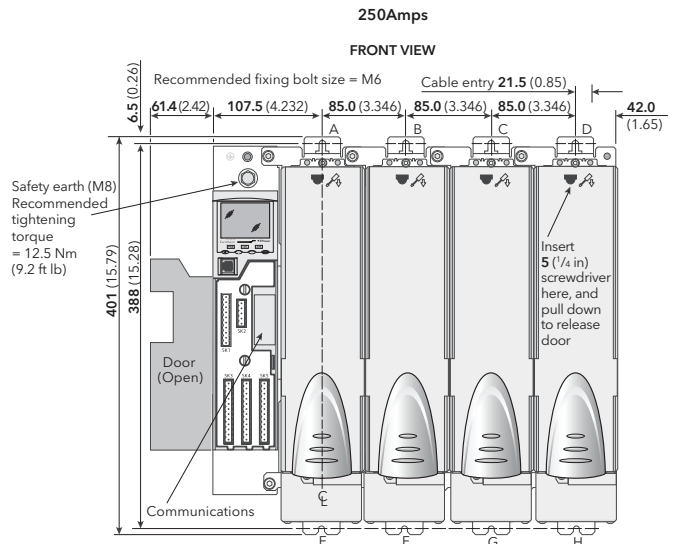
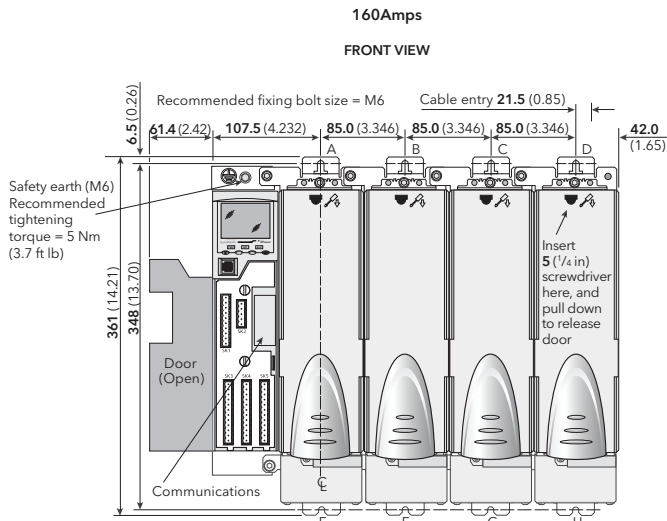

Order codes

EPOWER	1	2	3	4	5	6	7	8	9	10	11	12	13
14	15	16	17	18	19	20	21	22	23	24	25	26	27
28	29	30	31	32	33	34	35	36	37				

The code is divided in three sections:

- 1 Hardware, which defines the type, number and size of the unit and/or the modules.
- 2 Optional hardware and software functions.
- 3 QuickStart which is intend to configure the unit for maximum 60 to 80% of the application (single unit in 1, 2 or 3 legs configuration)

The code can then be either "Short" and include only the main hardware fields or "medium" and combine the hardware + the optional fields, or finally "Long" with the additional quick start code at the end.

Basic Product		4 Warranty		12 Predictive Load Management		19 Language	
EPOWER	Power Controller	XXX	Standard	XXX	None	ENG	English
1	Phase/Amps	WL005	5 Year	PLM	Predictive Load Management	FRA	French
1PH-50A	1 Phase unit 50A	USWL3	US Extended	13	External Feedback	GER	German
1PH-100A	1 Phase unit 100A			XX	None - Standard unit	ITA	Italian
1PH-160A	1 Phase unit 160A			XF	External feedback*	SPA	Spanish
1PH-250A	1 Phase unit 250A			* Factory option			
1PH-400A	1 Phase unit 400A			14	Remote Panel		
1PH-500A	1 Phase unit 500A			XX	None		
1PH-630A	1 Phase unit 630A			32ENG	32h8e English	20	Load Current (nominal)
2PH-50A	2 Phase unit 50A			32FRA	32h8e French	16A	16 Amps
2PH-100A	2 Phase unit 100A			32GER	32h8e German	25A	25 Amps
2PH-160A	2 Phase unit 160A			32ITA	32h8e Italian	40A	40 Amps
2PH-250A	2 Phase unit 250A			32SPA	32h8e Spanish	50A	50 Amps
2PH-400A	2 Phase unit 400A					63A	63 Amps
2PH-500A	2 Phase unit 500A					80A	80 Amps
2PH-630A	2 Phase unit 630A					100A	100 Amps
3PH-50A	3 Phase unit 50A					125A	125 Amps (Note 1)
3PH-100A	3 Phase unit 100A					160A	160 Amps (Note 1)
3PH-160A	3 Phase unit 160A					200A	200 Amps (Note 1)
3PH-250A	3 Phase unit 250A					250A	250 Amps (Note 1)
3PH-400A	3 Phase unit 400A					315A	315 Amps (Note 1)
3PH-2500A	3 Phase unit 250A					400A	400 Amps (Note 1)
3PH-630A	3 Phase unit 630A					500A	500 Amps (Note 1)
4PH-50A	4 Phase unit 50A					630A	630 Amps (Note 1)
4PH-100A	4 Phase unit 100A						
4PH-160A	4 Phase unit 160A						
4PH-250A	4 Phase unit 250A						
4PH-400A	4 Phase unit 400A						
4PH-500A	4 Phase unit 500A						
4PH-630A	4 Phase unit 630A						
PWR-50A	50A Power module						
PWR-100A	100A Power module						
PWR-160A	160A Power module						
PWR-250A	250A Power module						
PWR-400A	400A Power module						
PWR-500A	500A Power module						
PWR-630A	630A Power module						
DRV-XXX	Driver module only						
2	Voltage						
600V	100V to 600V						
690V	100V to 690V						
XXX	For Driver mod only						
3	Fan Supply						
230V	230V ac \geq 160A						
115V	115V ac \geq 160A						
XXX	No fan \leq 100A						
5	Internal Use						
XXX	None						
6	Internal Use						
XXX	None						
7	Option						
XX	None - End of Code						
00	Unit with options and/or quick start definition						
8	Communications Protocol						
XX	No optional fieldbus communication						
Y2	2-wire 485 Modbus (RJ45 connector)						
PB	Profibus-DPV1 (with D type connector)						
ET	Modbus-TCP						
DN	DeviceNet						
IP	Ethernet/IP						
CC	CC-Link						
PN	Profinet IO						
9	Module 1						
XX	None						
IO	IO optional board						
10	Module 2						
XX	None						
IO	IO optional board						
11	Module 3						
XX	None						
IO	IO optional board						
15	Software Option 1						
XXX	None						
EMS	Energy Measurement (Counter)						
LTC	Load Tap Changer						
16	Software Option 2						
XXX	None						
EMS	Energy Measurement (Counter)						
LTC	Load Tap Changer						
17	Not Used						
XX	Default						
18	Quick Start						
XX	None - End of code						
QS	Quick Start config						
21	Load Voltage (nominal)						
100V	100 Volts						
110V	110 Volts						
115V	115 Volts						
120V	120 Volts						
127V	127 Volts						
200V	200 Volts						
208V	208 Volts						
220V	220 Volts						
230V	230 Volts						
240V	240 Volts						
277V	277 Volts						
380V	380 Volts						
400V	400 Volts						
415V	415 Volts						
440V	440 Volts						
460V	460 Volts						
480V	480 Volts						
500V	500 Volts						
575V	575 Volts						
600V	600 Volts						
660V	660 Volts (Note 2)						
690V	690 Volts (Note 2)						



22 Control Type (Note 3)

1P	Single phase
2P	Two phase control
3P	Three phase control

23 Load Configuration (Note 4)

1P	Single phase
3S	Star
3D	Delta
4S	Star with neutral
6D	Open delta

24 Load Type

XX	Resistive
TR	Transformer primary

25 Firing Mode (Note 5)

PA	Phase angle
HC	Half cycle
BF	Burst firing (default 16 cycles)
FX	Fix modulation period (default 2 seconds)
LG	Logic mode

26 Feedback

V2	RMS load voltage squared
I2	RMS load current squared
TP	True power
VR	RMS load voltage
IR	RMS load current
OL	Open loop

27 Current Transfer Mode (Linear Current Limit) (Note 6)

XXX	Off
I2	RMS load current squared transfer
IR	RMS load current transfer

28 Analogue Input 1 Function (Note 6)

XX	None
SP	Setpoint
HR	Setpoint limit
IL	Current limit
VL	Voltage limit
PL	Power limit
TS	Current transfer span

29 Analogue Input 1 Type

XX	None
1V	1-5 Volt
2V	2-10 Volt
5V	0-5 Volt
0A	0-20 mA
4A	4-20 mA

30 Analogue Input 2 Function (Note 6)

XX	None
SP	Setpoint
HR	Setpoint limit
IL	Current limit
VL	Voltage limit
PL	Power limit
TS	Current transfer span

31 Analogue Input 2 Type

XX	None
0V	0-10 Volt
1V	1-5 Volt
2V	2-10 Volt
5V	0-5 Volt
0A	0-20 mA
4A	4-20 mA

32 Analogue Output Function

XX	None
X	None
V	Voltage
I	Current
P	Power
R	Impedance

33 Analogue Output Type

XX	None
0V	0-10 Volt
1V	1-5 Volt
2V	2-10 Volt
5V	0-5 Volt
0A	0-20 mA
4A	4-20 mA

34 Digital Input 2 Function

XX	None
AK	Alarm acknowledgement
RS	Remote setpoint selection

35 Alarm Relay Configuration

XX	None
AA	Any alarm
PA	Process alarms
FB	Fuse blown

36 Load Management Configuration

XX	None - Load Management disabled
SH	Sharing
I1	Incremental Type 1
I2	Incremental Type 2
RI	Rotating Incremental
DC	Distributed Control
DI	Distributed Control and Incremental Control
RD	Rotating Distributed Control and Incremental Control

37 Predictive Load Management Address

XX	Predictive Load Management address (00 to 63) Default address 00
----	---

SPARE FUSE FOR POWER MODULES

Current rating amps	Fuse number
50A	CS179139U315
100A	CS179139U315
160A	CS179139U315
250A	CS179139U350
400A	CS179439U630
500A	CS029859U630
630A	CS029960U900

Notes

- The maximum nominal current selectable is the current rating selected in Field 1.
- Only available if 690V selected in Field 2.
- Selection dependent on number of Phases selected in Field 1.
1PH = IP only
2PH = IP or 2P only
3PH = IP or 3P only
4PH = IP or 2P only
- Selection dependent on number of Phases selected in Field 1.
1PH = 1P only
2PH = 1P, 3S or 3D only
3PH = Any
4PH = 1P, 3S or 3D only
If IP selected in Field 22 only option is IP.
- PA not selectable if 2P selected in Field 22.
HC not selectable if TR selected in Field 24.
- Except XX the selection in Fields 28 and 30 cannot be the same.

32h8e EPower Remote Panel



Model number 32h8e is a horizontal 1/8DIN indicator and alarm unit that performs the dual function of remote display for EPower and independent 'policeman'. The latter is intended to disconnect should an overtemperature (or other excess process condition) occur.

32h8e communicates with EPower using Modbus protocol via the EIA485 RJ45 connector located on the underside of the EPower controller.

The remote panel is normally ordered as an option with EPower units. It is a fixed hardware build consisting of a relay output in OP1 and an analogue output in OP3. There are no user communications since this is used to communicate with EPower and the supply is high voltage only (100-240Vac). The unit is configured using 'QuickStart' code on initial start up.

The 32h8e is based on a 32h8i indicator and has the same and additional features as this instrument. For features not covered please refer to HA029005.

The 32h8e displays EPower Current, Voltage, Power and Setpoint parameters for each EPower Network. The Setpoint of the EPower networks can be adjusted via the 32h8e HMI. Indication of selected setpoint is included: local or remote.

Wire sizes

The screw terminals accept wire sizes from 0.5 to 1.5mm (16 to 22AWG). Hinged covers prevent hands or metal making accidental contact with live wires. The rear screws should be tightened to 0.4Nm (3.3lb in).

⚠ Ensure that the supply to the unit does not exceed 240V ac +10%

Mechanical Details

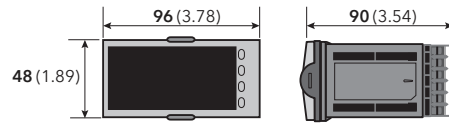

Panel cut-out 45 (1.77) (-0.0 +0.6) x 92 (3.62) (-0.0 +0.8)

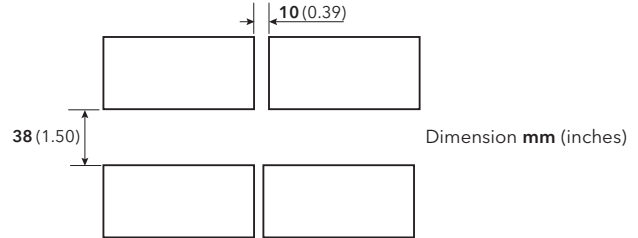

Recommended minimum spacing

If more than one unit is mounted in the same panel they should be spaced to allow sufficient air flow between them.

Rear Terminals

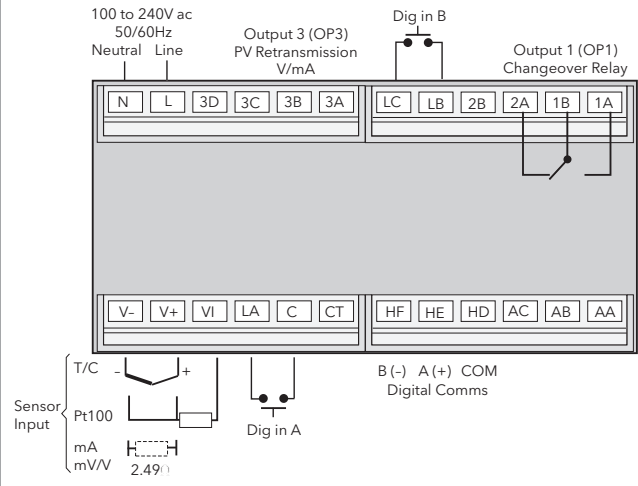

Example Wiring Diagram

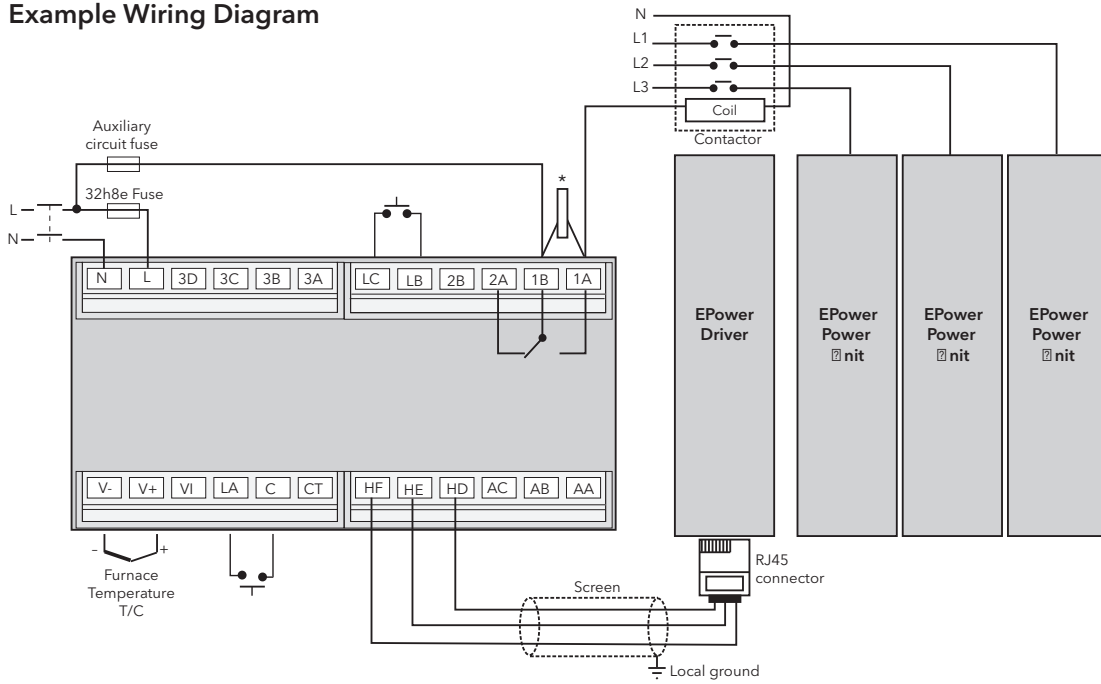

* General notes about relays and Inductive Loads

When switching inductive loads such as contactors or solenoid valves, wire the 22nF/100 'snubber' supplied across normally open relay terminals.

This will prolong contact life and reduce interference.

⚠ Snubbers pass 0.6mA at 110V and 1.2mA at 230V ac, which may be sufficient to hold on high impedance loads.

Specification - 32h8e Remote display

General

Environmental performance

Temperature limits	Operation:	0 to 55°C
	Storage:	-10 to 70°C
Humidity limits	Operation:	5 to 85% RH non condensing
	Storage:	5 to 85% RH non condensing
Panel sealing:		IP65, Nema 4X
Shock:		BS EN61010
Vibration:		2g peak, 10 to 150Hz
Altitude:		<2000 metres
Atmospheres:		Not suitable for use in explosive or corrosive atmosphere

Electromagnetic compatibility (EMC)

Emissions and immunity: BS EN61326

Electrical safety

(BS EN61010): Installation cat. II; Pollution degree 2

INSTALLATION CATEGORY II

The rate impulse voltage for equipment on nominal 230V mains is 2500V.

POLLUTION DEGREE 2

Normally, only non-conductive pollution occurs. Occasionally, however, a temporary conductivity caused by condensation shall be expected

Physical

Panel mounting:	1/8 DIN, horizontal
Dimensions and weight:	96mm (3.78") W x 48mm (1.89") H x 90mm (3.54 inches) D, 350g (0.77lbs)
Panel cut-out dimensions:	92mm (1.77 inches) W x 45mm (3.62 inches) H

Operator interface

Type:	LCD TN with backlight
Main PV display:	5 digits, green or red
Lower display:	9 character starburst, green
Status beacons:	Units, outputs, alarms

Power requirements

Voltage:	100 to 240V ac, -15%, +10%, max 9W
Frequency:	48 to 62Hz

Approvals

CE, cUL listed (file E57766)

Communications

Serial communications option	
Protocol:	Modbus RTU Master
Isolation:	264V ac, double insulated
Transmission standard:	EIA485 (2 wire)

The 32h8e has Modbus Master RS485 Comms with a fixed set of EPower Modbus addresses. Power up the display for the first time, configure the QuickStart code for the standard indicator functions, and the process values and alarm messages are immediately displayed, automatically configured to match the EPower display - for example RMS values or average values for current, voltage and power displayed as 3 phase or as several times single phase as defined by the EPower configuration.

32h8e Terminal			RJ45 Pin Number
HD	White/Green	Common	3
HE	Orange	Rx A(+)	2
HF	White/Orange	Tx B(-)	1

Process variable input

Calibration accuracy:	<±0.25% of reading ±1LSD (Note 1)
Sample rate:	9Hz(110ms)
Isolation:	264V ac double insulation from the PSU and communication
Resolution (µV):	<0.5µV with 1.6s filter (mV range) <0.25mV with 1.6s filter (Volts range)
Resolution (effective bits):	>17 bits
Linearisation accuracy:	< 0.1% of reading
Drift with temperature:	<50ppm (typical) <100ppm (worst case)
Common mode rejection:	48-62Hz, >-120db
Series mode rejection:	48-62Hz, >-93dB
Input impedance:	100MΩ (200KΩ on volts range C)
Cold junction compensation:	>30/1 rejection of ambient change
External cold junction:	Reference of 0°C

Cold junction accuracy:	<±1°C at 25°C ambient
Linear (process) input range:	-10 to 80mV, 0 to 10V
Thermocouple types:	K, J, N, R, S, B, L, T, C, custom download (Note 2)

Resistance thermometer types: 3-wire Pt100 DIN 43760

Bulb current:	0.2mA
Lead compensation:	No error for 22 ohms in all leads
Input filter:	Off to 100s
Zero offset:	User adjustable over full range
User calibration:	2-point gain & offset

Notes

- (1) Calibration accuracy quoted over full ambient operating range and for all input linearisation types
- (2) Contact Eurotherm for details of availability of custom downloads for alternative sensors

OP 1

Type:	Form C (changeover)
Rating:	Min 100mA @12V dc, max 2A@240V ac resistive
Functions:	Alarms, events

OP 3

Isolation:	264V ac double insulated
Functions:	Retransmission
Current output	Rating: 0-20mA into <500Ω Accuracy: ±(<0.25% of Reading + <50µA) Resolution: 13.6 bits
Voltage output	Rating: 0-10V into >500Ω Accuracy: ±(<0.25% of Reading + <25mV)
Resolution:	13.6 bits

Software features

Alarms

Number:	4
Type:	Absolute high & low, Rate of change (rising or falling)
Latching:	Auto or manual latching, non-latching, event only
Output assignment:	Up to four conditions can be assigned to one output
EPower Alarms:	Missing mains, Thyristor short circuit, Open thyristor, Fuse blown, Over temperature, Voltage dips, Frequency fault, Power module
24V fault, Total load failure, Chop off, Partial Load Unbalance, Volt module	Load Failure, Partial fault, Temperature pre alarm, Power wdog fault, Power module comms error, Power module timeout, Closed loop, Output fault

The pre-set alarms have a fixed medium priority enables indicator alarms to be configured as lower, the same or higher priority. EPower alarms can be globally acknowledged via the 32h8e HMI.

Other status outputs

Functions:	Including sensor break, power fail, new alarm, pre-alarm
Output assignment:	Up to four conditions can be assigned to one output

Custom messages

Number:	15 scrolling text messages
No of characters:	127 characters per message max
Languages:	English, German, French, Spanish, Italian
Selection:	Active on any parameter status using conditional command

Recipes

Number:	5 recipes with 19 parameters
Selection:	HMI interface, communications or digital IO

Other features

Display colour:	Upper display selectable green or red or change on alarm
Scrolling text:	Parameter help, custom messages
Display filter:	Off to zero last 2 digits
Peak monitor:	Stores high and low values

32h8e Initial configuration

At first switch on, after the start-up sequence, the initial configuration page is displayed.

Note: the following 'quickstart' description applies only to new (not previously configured) instruments. If the instrument has previously been configured (either at the factory or subsequently) the instrument starts up showing the relevant process value.

The initial display shows 'Set1' on the top line, with a coded display below with its first item flashing. The lower line is decoded as shown in table.

The 'mode' (up/down arrows) are used to scroll through the available choices for each item. Once the required value is displayed, the scroll key is used to select the next character for editing. Once all five characters have been edited, further operations of the scroll key call the range high display (allowing the high range value to be edited using the mode keys), then the range low display (allowing the low range value to be edited). A further operation calls the Set2 display, which is decoded in the table below.

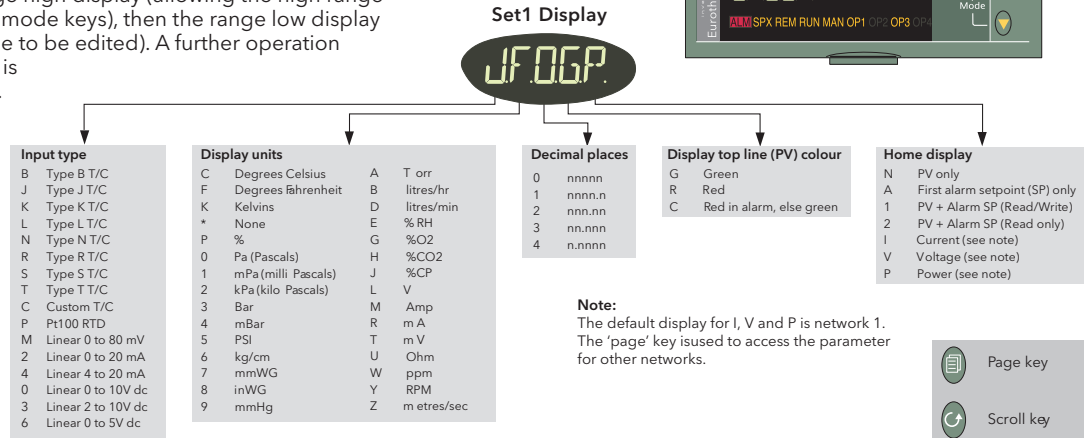

After Set2 parameters have been edited, a further operation of the scroll key invites the user to Exit. Operating the scroll key returns to the Set1 display; operating a mode key to display 'yes' quits the quickstart menu and causes the unit to enter operating mode.

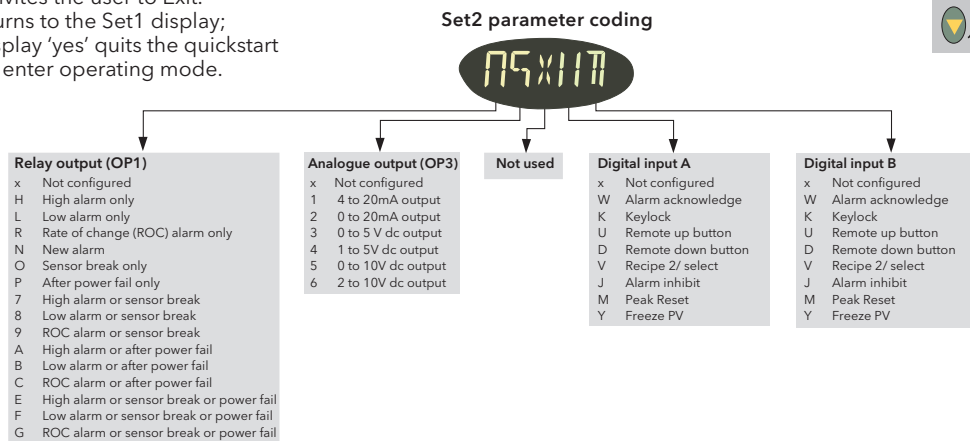

Eurotherm: International sales and service www.eurotherm.com

AUSTRALIA Sydney
T (+61 2) 9838 0099
E info.eurotherm.au@invensys.com

AUSTRIA Vienna
T (+43 1) 7987601
E info.eurotherm.at@invensys.com

BELGIUM & LUXEMBOURG Moha
T (+32) 85 274080
E info.eurotherm.be@invensys.com

BRAZIL Campinas-SP
T (+5519) 3707 5333
E info.eurotherm.br@invensys.com

CHINA
T (+86 21) 61451188
E info.eurotherm.cn@invensys.com

Beijing Office
T (+86 10) 5909 5700
E info.eurotherm.cn@invensys.com

DENMARK Copenhagen
T (+45 70) 234670
E info.eurotherm.dk@invensys.com

FINLAND Abo
T (+358) 22506030
E info.eurotherm.fi@invensys.com

FRANCE Lyon
T (+33 478) 664500
E info.eurotherm.fr@invensys.com

GERMANY Limburg
T (+49 6431) 2980
E info.eurotherm.de@invensys.com

INDIA Chennai
T (+91 44) 24961129
E info.eurotherm.in@invensys.com

IRELAND Dublin
T (+353 1) 4691800
E info.eurotherm.ie@invensys.com

ITALY Como
T (+39 031) 975111
E info.eurotherm.it@invensys.com

KOREA Seoul
T (+82 31) 2738507
E info.eurotherm.kr@invensys.com

NETHERLANDS Alphen a/d Rijn
T (+31 172) 411752
E info.eurotherm.nl@invensys.com

NORWAY Oslo
T (+47 67) 592170
E info.eurotherm.no@invensys.com

POLAND Katowice
T (+48 32) 78395000
E info.eurotherm.pl@invensys.com

SPAIN Madrid
T (+34 91) 6616001
E info.eurotherm.es@invensys.com

SWEDEN Malmo
T (+46 40) 384500
E info.eurotherm.se@invensys.com

SWITZERLAND Wollerau
T (+41 44) 7871040
E info.eurotherm.ch@invensys.com

UNITED KINGDOM Worthing
T (+44 1903) 268500
E info.eurotherm.uk@invensys.com

U.S.A. Ashburn VA
T (+1 703) 724 7300
E info.eurotherm.us@invensys.com

ED61

© Copyright Eurotherm Limited 2010

Invensys, Eurotherm, the Eurotherm logo, Chessell, EurothermSuite, Mini8, Eycon, Eyris, EPower nanodac and Wonderware are trademarks of Invensys plc, its subsidiaries and affiliates. All other brands may be trademarks of their respective owners.

All rights are strictly reserved. No part of this document may be reproduced, modified, or transmitted in any form by any means, nor may it be stored in a retrieval system other than for the purpose to act as an aid in operating the equipment to which the document relates, without the prior written permission of Eurotherm limited.

Eurotherm Limited pursues a policy of continuous development and product improvement. The specifications in this document may therefore be changed without notice. The information in this document is given in good faith, but is intended for guidance only.

Eurotherm Limited will accept no responsibility for any losses arising from errors in this document.

i n v e n s y s
Operations Management